

WALL MOUNTED ELECTRIC FIREPLACE HEATER

Model # :

80001 - Onyx

80002 - Ivory

80008 - Mirror

80026 - Stainless

OWNER'S MANUAL

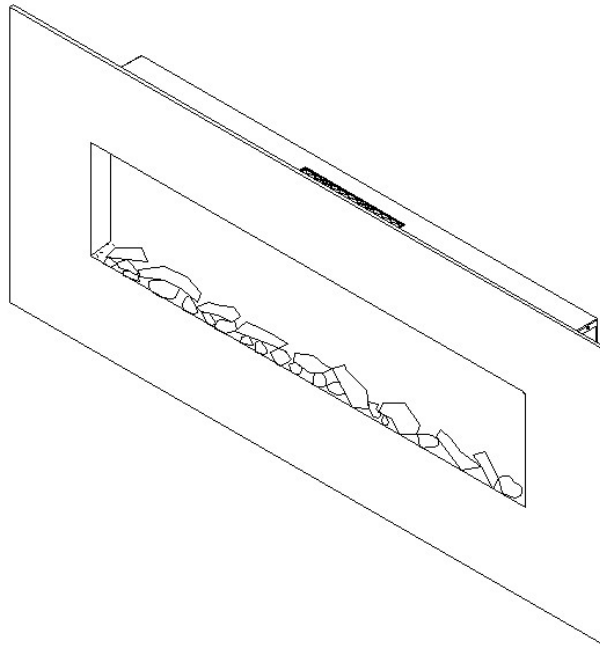

AC 110-120V 60Hz 1500W

⚠ WARNING

Read and understand this entire owner's manual, including **all safety information**, before plugging in or **using** this product. Failure to do so could result in **fire, electric shock, or serious personal injury**.

⚠ CAUTION

Keep this owner's manual for future reference. If you sell or give this product away, **make sure this manual accompanies this product**.

touchstone
Smart Furniture. Beautiful Solution.



Table of Contents

Contents

General Information	5
<i>CSA Approval Listing Information</i>	5
<i>Fireplace Specifications</i>	5
<i>Dimensional Drawings</i>	6
Unpacking Your Fireplace	7
<i>Parts and Hardware</i>	7
Tools Required.....	7
What’s in the Box	7
<i>Unpacking and Setup</i>	7
Unpacking Instructions:.....	7
Testing the Fireplace Prior to Installation.....	8
3-prong Outlet Installation.....	8
Installation	9
WARNINGS	9
<i>Choosing Installation Location</i>	9
Choosing Wall Location	9
<i>Removing The Wall Mount Bracket From Fireplace</i>	10
<i>Removing The Glass Panel</i>	11
<i>Wall Mounted Installation</i>	12
<i>Heat Disable Switch</i>	14
<i>Hanging Fireplace On Mounting Bracket</i>	15
<i>Installing Logs and Glass Crystals</i>	16
Faux Log Installation Instructions	16
Glass Crystal Installation Instructions	17
Operating Fireplace	19
<i>Power</i>	19
<i>Methods of Operation</i>	20
Control Panel and Remote Control Functions	20
<i>Remote Control Operation</i>	20
<i>Temperature Limiting Control</i>	21
Care and Maintenance	22
<i>Cleaning</i>	22
<i>Maintenance</i>	22
Warranty	23

IMPORTANT SAFETY INFORMATION WARNING!

- **THIS FIREPLACE IS HOT WHEN IN OPERATION AND CAN CAUSE SEVERE BURNS**
- Do not operate fireplace before reading and understanding operating instructions. Failure to operate fireplace according to operating instructions could cause fire or injury.
- Risk of burns. This fireplace is HOT when in operation and heating element is ON. Power to the fireplace should be turned off and the fireplace allowed to cool before servicing. To disconnect power to the fireplace, turn controls to off, then remove plug from outlet.
- Do not install damaged, incomplete, or substitute components.
- Young children should be carefully supervised when they are in same room with fireplace. Toddlers, young children and others may be susceptible to accidental contact burns. A physical barrier is recommended if there are at risk individuals in the house. To restrict access to the fireplace, install an adjustable safety gate to keep toddlers, young children and other at risk individuals away from the fireplace and hot surfaces.
- Clothing and other flammable material should not be placed on or near the fireplace.
- Due to high temperatures, the fireplace should be located out of traffic and away from furniture and draperies.
- Ensure that you have incorporated adequate safety measures to protect infants/toddlers from touching hot surfaces.
- It is imperative that that the control compartments, circulating blower, and its passageway is the fireplace is kept clean.
- Under no circumstances should this fireplace be modified.
- Do not use the fireplace if any part has been under water.
- Do not operate the fireplace with the glass panel removed, cracked or broken.
- Keep the packaging material out of the reach of children. As with all plastic bags, these are not toys and should be kept away from children and infants.
- Servicing should only be done while the fireplace is disconnected from the power outlet.
- Unplug fireplace if not being used for an extended period of time.
- Do not operate this fireplace with a damaged cord or plug after the fireplace malfunctions, has been dropped, or damaged in any manner.
- Do not use outdoors.
- Never locate fireplace where it may fall into a bathtub or other water container.
- Do not run the cord under carpeting. Do not cover cord with throw rugs, runners, or the like. Arrange cord away from traffic area and where it will not be tripped over.
- Connect to properly grounded outlets only.
- Do not insert foreign objects into any ventilation or exhaust opening as this may cause and electric shock, fire, or damage to the fireplace.
- To prevent a possible fire, do not block the air intakes or exhaust in any manner. Do not use on soft surfaces, like a carpet, where openings may be blocked.
- Ensure clearances to combustibles are maintained when building a mantel or shelves above the fireplace. Elevated temperatures on the wall or in the air above the fireplace can cause melting, discoloration or damage to the decorations, a TV or other electronic components.

General Information

CSA Approval Listing Information

This fireplace has been tested in accordance with the CSA Standards for fixed and location-dedicated electric room appliances in the United States and Canada. If you need assistance during installation, please contact our technical support department at 800-215-1990 option 2.

Note: This fireplace must be electrically wired and grounded in accordance with local codes or, in the absence of local codes, with National Electric Code ANSI/NFPA 70-latest edition in the United States or the Canadian Electric Code, CSA C22.1 in Canada.

Fireplace Specifications

Model Number	80001	80002	80008	80026
Description	Onyx	Ivory	Mirror	Stainless
Voltage	120v AC	120v AC	120v AC	120v AC
Watts	Max 1500W	Max 1500W	Max 1500W	Max 1500W
Amps	15 AMP Grounded Circuit	15 AMP Grounded Circuit	15 AMP Grounded Circuit	15 AMP Grounded Circuit
Fireplace Width	50.4"	50.4"	50.4"	50.4"
Fireplace Height	21.65"	21.65"	21.65"	21.65"
Fireplace Depth	5.5"	5.5"	5.5"	5.5"
Net Weight	50 lbs	50 lbs	50 lbs	50 lbs
Shipping Weight	55 lbs	55 lbs	55 lbs	55 lbs

Dimensional Drawings

80001/80002/80008/80026 – Dimensions

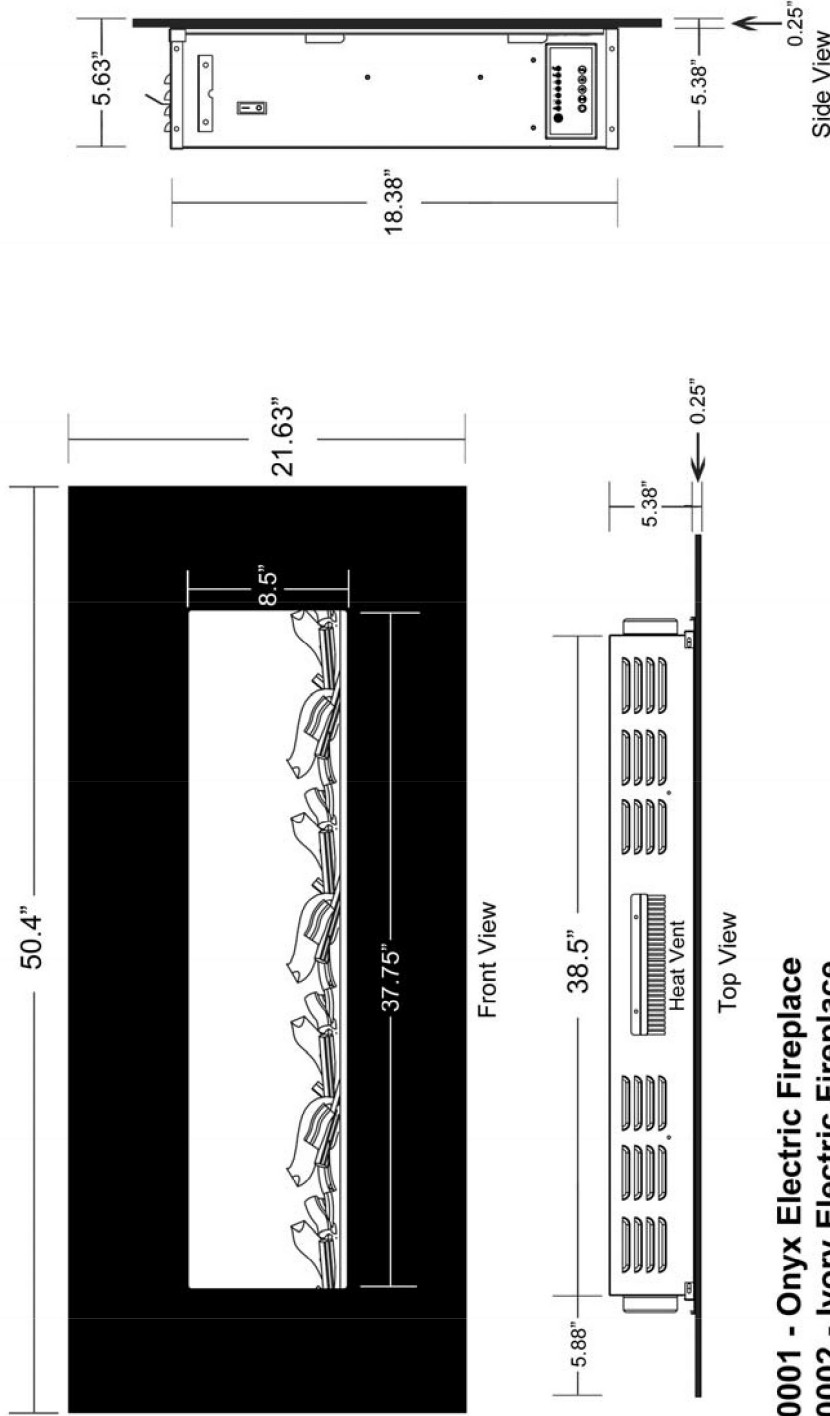

- 80001 - Onyx Electric Fireplace
- 80002 - Ivory Electric Fireplace
- 80008 - Mirror Electric Fireplace
- 80026 - Stainless Electric Fireplace

Features

- 2 heat settings (high and low)
- Includes bracket for wall mounting
- Remote control for heat and flame setting (batteries not included)
- Dual mode, operates with or without heat for only flame effect
- Built in timer mode for shut off in 30 minutes to 7.5 hours.
- Faux Fire Log and Glass Crystal Media Options

Specifications

- Frame color: Black, Ivory, Mirror
- Watts: 1,500
- BTU's: 5,118
- Room Coverage: 400 ft.
- Voltage: 120v
- Amperes: 11 and up

Touchstone Wall Mounted Fireplaces
 PN: 80001, 80002, 80008, 80026











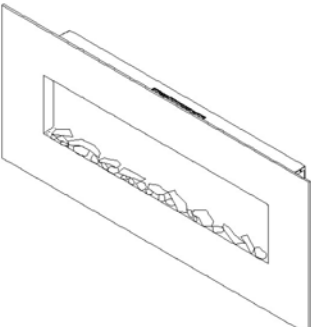

Unpacking Your Fireplace

Parts and Hardware

Tools Required

- Phillips-head screwdriver
- Stud finder
- Level
- Tape measure
- Electric drill
- 1/4" wood drill bit

What's in the Box

  Wall Bracket	 Wood Screws **screws not drawn to scale**	 Drywall anchors **anchors not drawn to scale**
	 Remote Control	
	 Crystal Embers	 Plastic Tray
 Fire Log	 Cord Cover	 Cord Corner

Unpacking and Setup

Unpacking Instructions:

- Remove all parts and hardware from the carton and place them on a clean, soft, dry surface. Check the parts list to make sure no parts are missing. If parts are missing, please contact technical support at 800-215-1990 opt 2. for replacement parts.

NOTE: Dispose of plastic bag, as it may cause choking hazard with young children. Do not let children play with plastic bag.

Wiring

Touchstone Wall Mounted Electric Fireplaces come with a 3-prong plug which plugs into any standard 110v outlet.

Testing the Fireplace Prior to Installation

- Before installing the fireplace, test the fireplace to make sure that it operates properly.
- Plug fireplace into approved outlet and power on fireplace. Once fireplace is tested, continue with installation.
- If you have any problems, please contact technical support at 800-215-1990 opt 2.

3-prong Outlet Installation

- Only use this fireplace on a 120V AC, 15-Amp grounded circuit. Never overload the circuit. If this fireplace trips the circuit breaker, unplug all other appliances on the same circuit before the next use. Avoid plugging other appliances into the same circuit as this fireplace.
- Always check the fireplace plug and connections before each use.
- Never plug this fireplace into an outlet that is cracked or has any loose wires or connections. Plugging this fireplace into a faulty outlet could result in the outlet overheating or catching fire.
- Make sure this plug fits securely into the outlet. Faulty wall outlet connections or loose plugs can cause the outlet to overheat. If the outlet or faceplate is hot, discontinue use immediately and have a qualified electrician inspect and/or replace the faulty outlet.
- The power cord supplied with the heater has three prongs: two flat blades (live and neutral) and one round pin (ground). If a 3-slot receptacle is not available, an adapter **MUST** be used. The adapter **MUST** be properly grounded to the outlet box (see figure below).

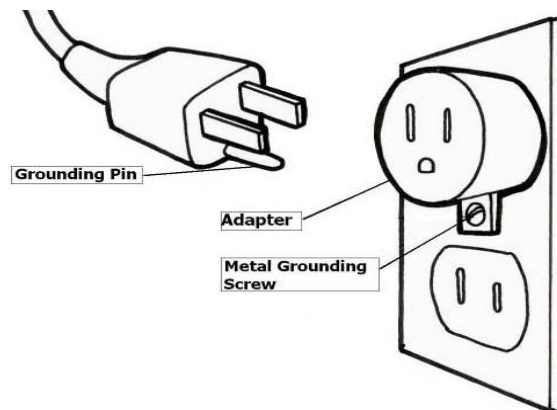

NOTE: Adapter NOT INCLUDED.

Installation

WARNINGS

- Due to high temperatures, keep the fireplace out of high traffic locations.
- Keep combustible materials, such as furniture, pillows, bedding, papers, clothes, and curtains at least 36” away from the front of the fireplace.
- Never install the fireplace where it may fall into a bathtub or other body of water.
- Wear safety gloves and safety glasses for protection during installation. Broken glass may cause injury or harm.
- Prevent contact with loose insulation. Do not install the fireplace against a vapor barrier or exposed insulation.
- Do not expose the fireplace to the elements (rain, etc).

Choosing Installation Location

Choosing Wall Location

- Measure wall location to ensure that fireplace will fit on desired wall location.
- Minimum clearances (measurements taken from front of glass panel):

Bottom of Fireplace to Floor:	6”	Top of Fireplace:	24” to mantel
Sides of Fireplace:	6”	Top of Fireplace:	24” to TV
Back of Fireplace:	0”	Top of Fireplace:	24” to ceiling

- Select a location that is not prone to moisture and is located at least 36” away from combustible materials such as curtains, drapes, furniture, bedding, or other combustible materials.
- See Safety Information on pages 3 for warnings about safe placement, safe installation, and proper use of this product.

Removing The Wall Mount Bracket From Fireplace

Tools:

- Phillips-head screw driver

Instructions:

1. Take the fireplace out of the packaging and place it on a flat, non-abrasive surface.
2. Remove off the screws on both sides with a Phillips-head screwdriver, then take off the wall bracket. The bracket must be held tightly while screws are being removed, to avoid them from falling on the fireplace and causing damage or injury.

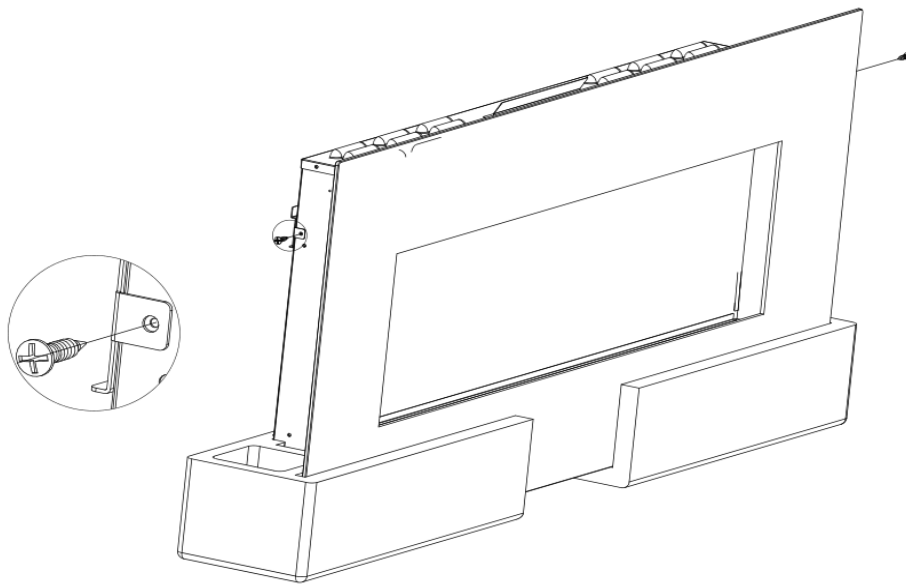

3. Put the mounting bracket and screws off to the side for mounting to the wall.

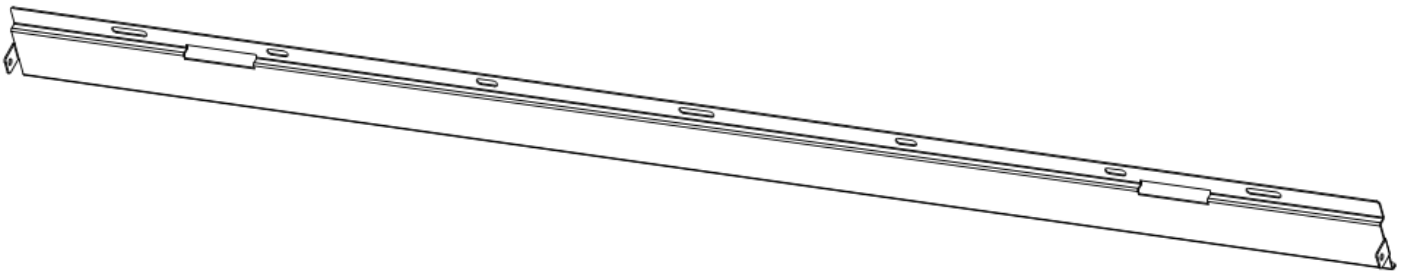

Removing The Glass Panel

Prior to installation, it is best to remove the glass panel. Please remove glass panel as per instructions below:

Tools Needed:

- Phillips Screwdriver

Instructions:

1. Locate the 2 screws on the top of the fireplace (A and B) that attach the glass panel to the fireplace. Remove both screws to remove the glass panel from the firebox.

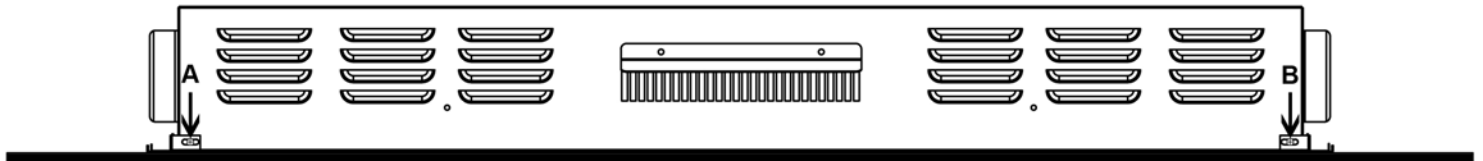

Top View of Fireplace

2. Carefully, lift and remove the glass panel from the front of the fireplace. The front panel hooks onto the fireplace unit. With 2 people, lift the panel toward the ceiling and then pull the panel out away from the unit. Install replacement glass.



a. lift glass panel UP



b. pull glass panel away from wall

NOTE: While we show only 1 person removing the glass, we recommend that 2 people remove the glass from the fireplace unit.

Wall Mounted Installation

- Due to many different finish materials use on walls, it is highly recommended that you consult your local builder before you install this fireplace on the wall.
- Select a location that is not prone to moisture and is located at least 36” away from combustible materials such as curtains, drapes, furniture, bedding, or other combustible materials.

Instructions

1. Select a location that is not prone to moisture and is located at least 36” away from combustible materials, such as curtains, drapes, furniture, bedding, paper, etc.
2. With glass panel removed (see p.11 for instructions on removing glass panel), have two people hold the fireplace against the wall to determine the final location.
3. Place the unit face down on a soft, non-abrasive surface. Locate the mounting bracket that was removed on p.10.
4. Locate the wall studs using an electronic stud-finder. It is recommended that the mounting bracket be fastened to at least 2 studs (3 studs recommended).

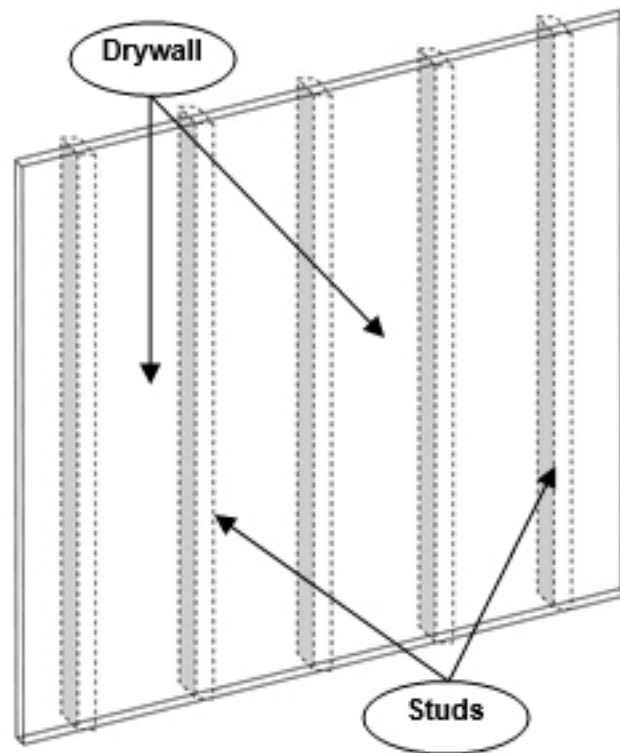

Wall Mounted Installation – cont.

5. Using the wall mount bracket as a template, mark the holes on the wall at least 8” apart, with 3 of the holes preferably on 3 studs.

When hanging the wall bracket, it is recommended to fasten the mounting bracket to 3 studs. If fastening to 3 studs, no dry wall anchors would need to be used. If fastening to only 2 studs, then 3 dry wall anchors would need to be used to fasten the mounting bracket to the wall.

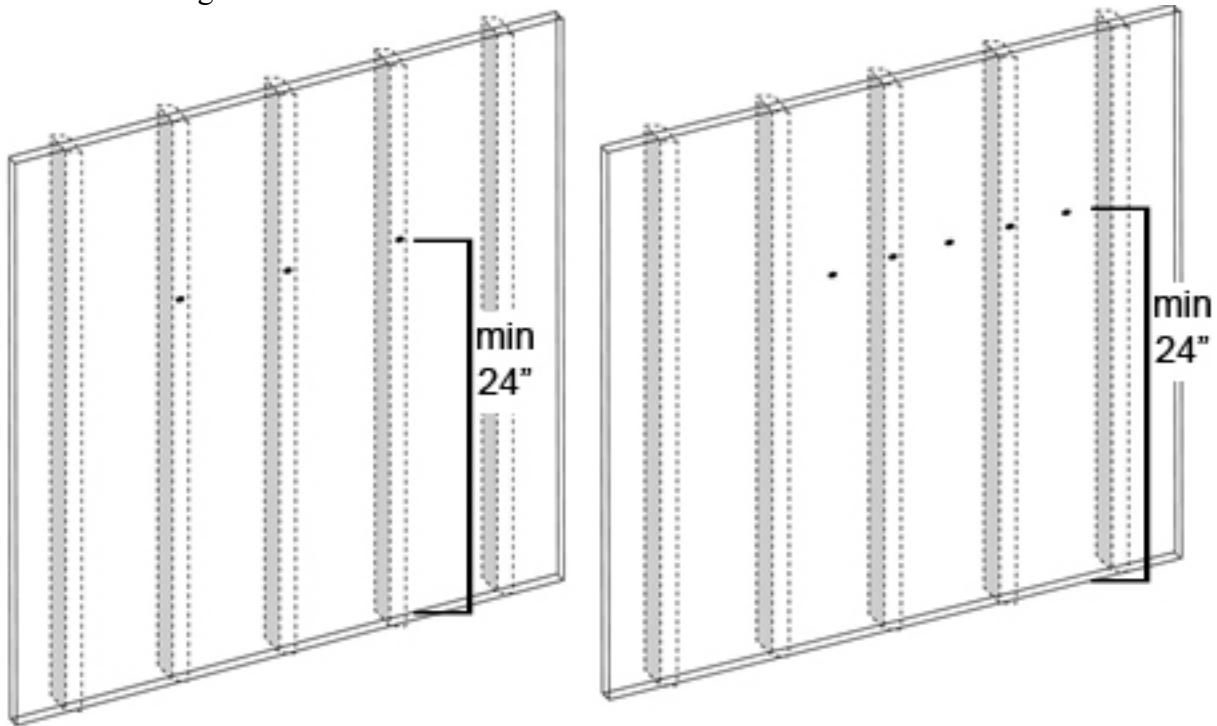

Note: The minimum height from the bottom of the fireplace, once hung on the wall, to the surface below must be at least 6”. To meet this criteria, the wall mount bracket should be hung no lower than 24” from the ground to the top of the mounting bracket when hung on the wall.

6. Once the holes are marked, use a ¼” drill bit to drill a pilot hole. If the screws will go into 3 studs, then no drywall anchors are needed. If screws only go into 2 studs, you will need to use 3 drywall anchors. Tap the drywall anchors into the wall until they are flush with the drywall surface.

Mounting into three wall studs

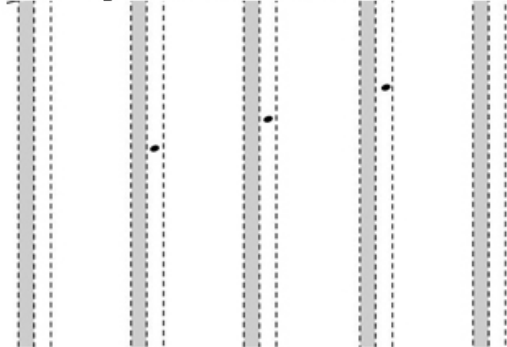

Mounting into two wall studs and drywall anchors

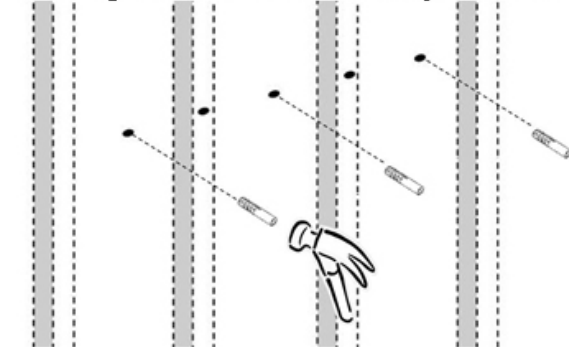

Wall Mounted Installation – cont.

7. Align the holes in the wall bracket with the pilot holes and drywall anchors. Thread wood screws into the holes in the wall bracket and then directly into the wall studs and/or drywall anchors. Make sure the bracket is level and tighten all screws securely.

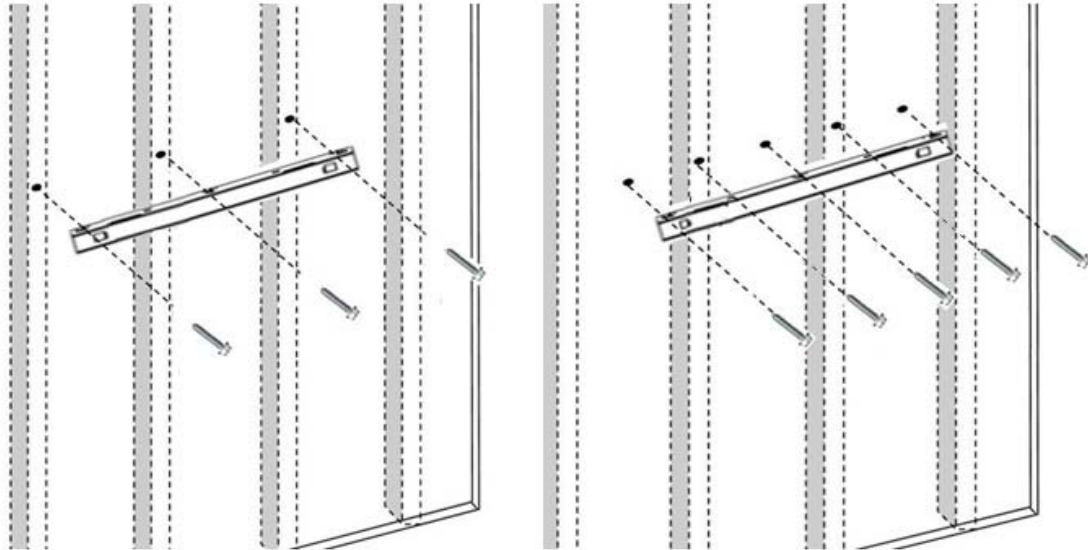

8. Once the bracket is secured to the wall, the fireplace may now be hung on the bracket.

Heat Disable Switch

Touchstone Wall Mounted Electric Fireplaces include a heat disable switch for disabling and enabling the fireplace's heating element. The heat disable switch is located on the back of the unit under the trap door (shown below). This switch must be in the ON position for the heater to operate. For installations where the heating element is not needed, flip the switch to the OFF (0) position.

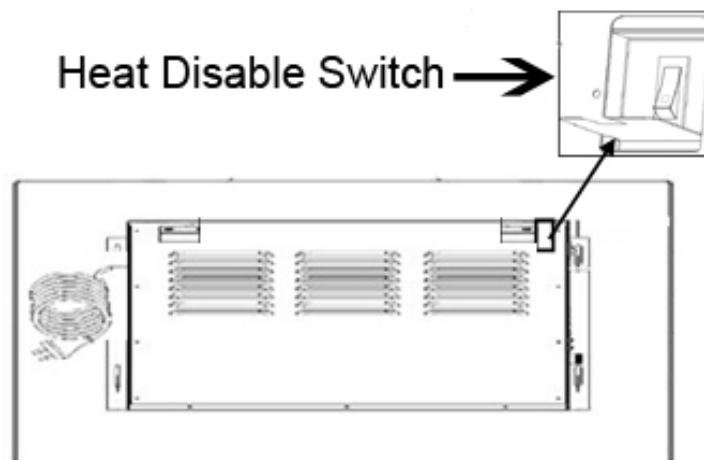

Hanging Fireplace On Mounting Bracket

1. With the help of a capable adult, lift the fireplace (A) and align the hooks (E) on the back of the fireplace with the slots in the wall bracket. Carefully set the hooks (E) in the slots.

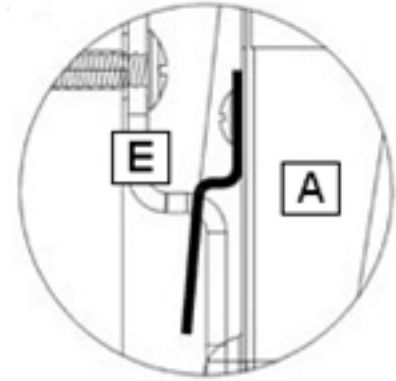
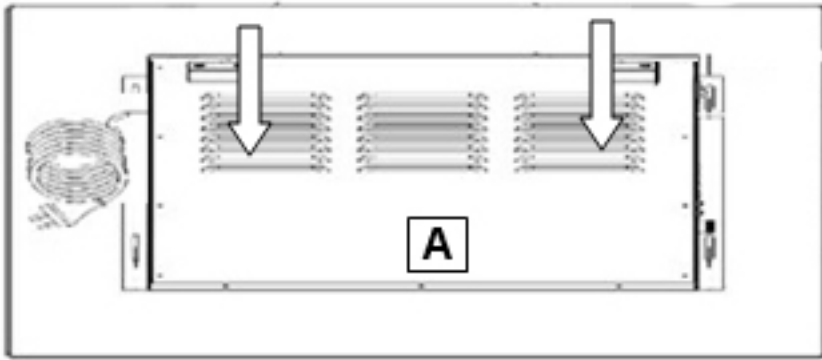

2. Secure the fireplace to the wall bracket with the 2 screws (D), one on each side, removed from the mounting bracket when the fireplace was unpacked. Thread the screws through the wall bracket and into the fireplace. Tighten both screws with a Phillips-head screwdriver.

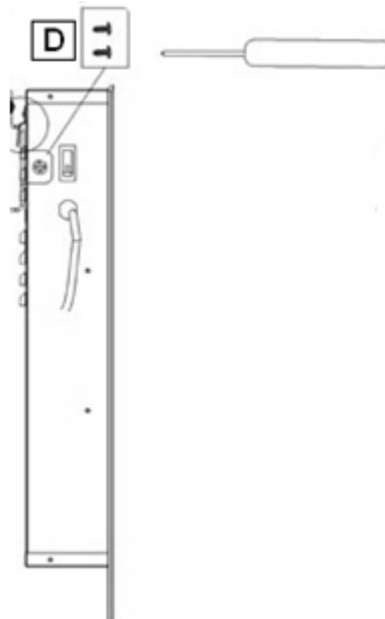

Installing Logs and Glass Crystals

Touchstone Electric Wall Mounted Electric Fireplaces come with both a faux log bed and glass crystals. To achieve the desired look, the user can install either the faux log bed or the glass crystals. Both options cannot be used at the same time.

Faux Log Installation Instructions

1. With the glass panel removed, place the faux log bed in place.

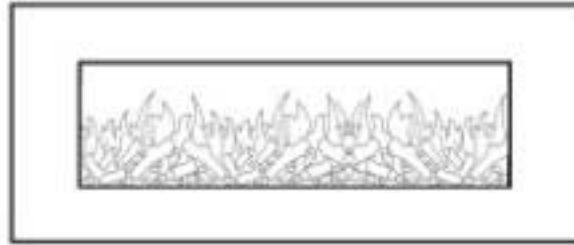

2. Once installed, reinstall the glass panel and secure the glass panel with the 2 screws on the top of the fireplace.

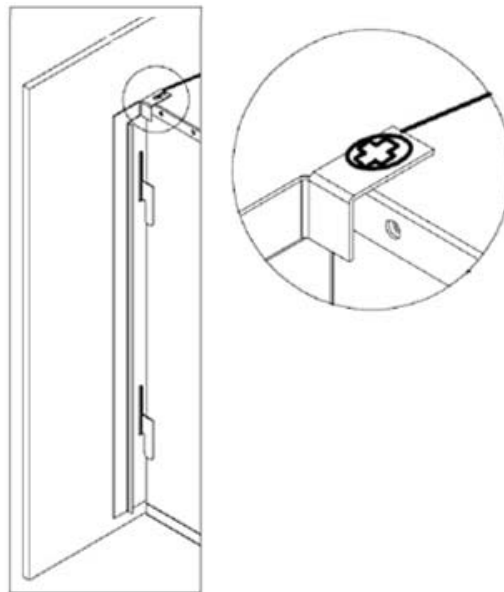

3. The fireplace is now ready for use.

Installing Logs and Glass Crystals - cont

Glass Crystal Installation Instructions

1. Set the shelf onto the ledge in the opening at the front of the fireplace.

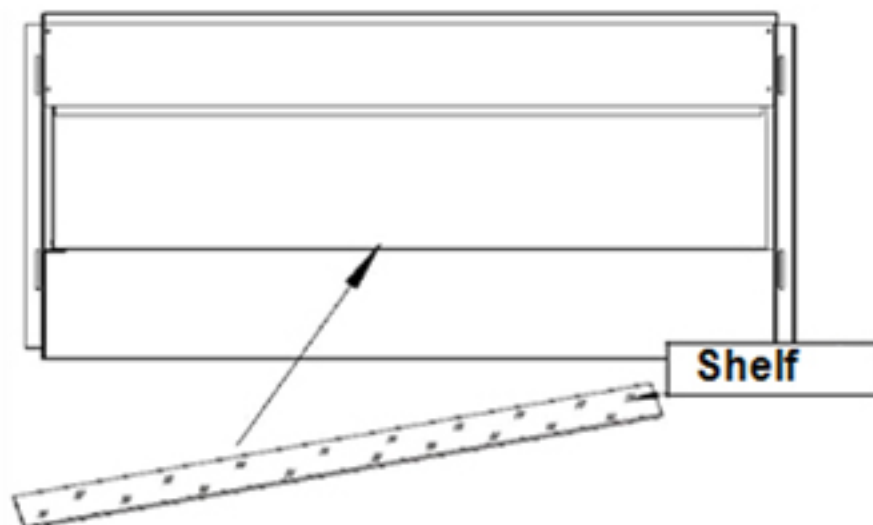

2. Arrange the decorative crystals on the shelf in the desired position.

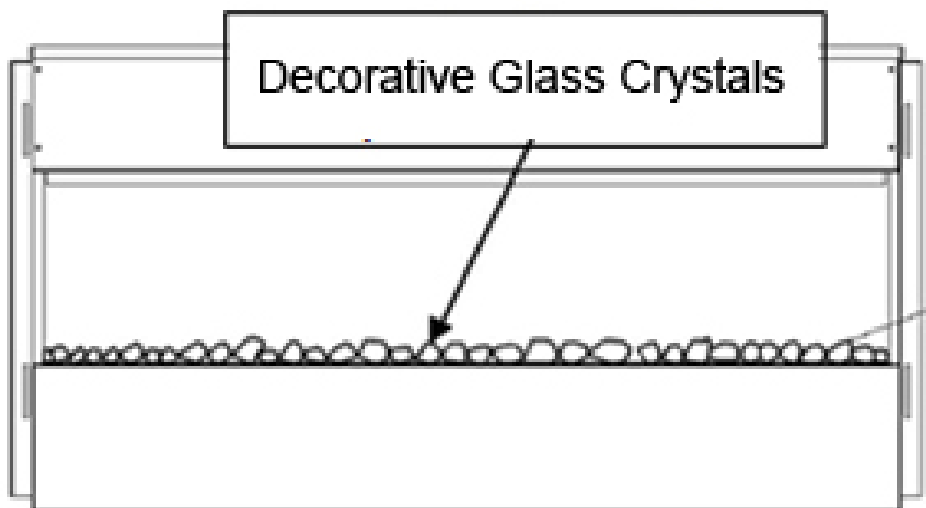

Installing Logs and Glass Crystals - cont

Glass Crystal Installation Instructions - cont

3. Once installed, reinstall the glass panel and secure the glass panel with the 2 screws on the top of the fireplace.

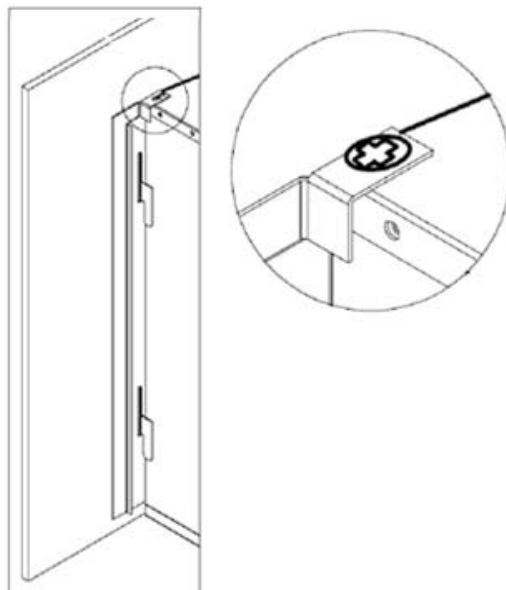

4. The fireplace is now ready for use.

Operating Fireplace

Once the fireplace has been plugged into a grounded outlet, the fireplace is now ready for operation. Ensure that the house circuit breakers for the power supply are turned on.

Power

Plug the power cable into a 110v 15 amp grounded outlet. Make sure the outlet is in good condition and that the plug is not loose. **NEVER** exceed the maximum amperage for the circuit. **DO NOT** plug other appliances into the same circuit.

Once the unit is plugged into the outlet, flip the main power switch on the left side of the unit to the ON position to operate the fireplace.

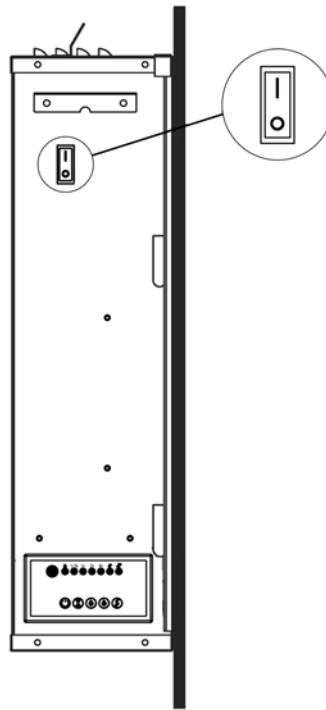





BUTTON	FUNCTION	ACTION & INDICATION
<p>ON</p>  <p>OFF</p>	<p>ON (I). Enables all functions.</p> <p>OFF (O). Turns off all functions on control panel and remote control.</p>	<p>1. Press ON (I). Power turns on. All functions are enabled.</p> <p>2. Press OFF (O). Power, flame effect, and all functions turn off.</p>

Note: The fireplace's control panel and remote control will not work if this switch is not in the ON position.

Methods of Operation

This electric fireplace can be operated by the CONTROL PANEL, located in the upper right vent in the front glass panel, or by the REMOTE CONTROL. The operation and functions of both methods are the same

Control Panel and Remote Control Functions

BUTTON	FUNCTION	ACTION & INDICATION
 POWER	<p>ON: Enables control panel functions and remote control. Turns on the flame effect.</p> <p>OFF: Disables control panel functions and remove control. Turns off the flame effect.</p>	<p>1. Press once. Indicator light turns on. Power turns on. All functions enabled.</p> <p>2. Press again. Flame effect turns off. Unit goes to standby. All functions turn off.</p>
 TIMER	<p>TIMER button: Control time settings to turn off fireplace at selected time.</p> <p>Settings range from 0.5 hours to 7.5 hours.</p>	<p>1. Press once. Indicator light turns on. Timer is set to 0.5 hours.</p> <p>2. Press again until desired setting is reached. Indicator lights show setting.</p>
 FLAME +	<p>FLAME +: Makes flame effect brighter.</p> <p>NOTE: Flame effect stays on until power button is turned off. Flame effect must be on for heater to turn on.</p>	<p>1. Press once: Flame effect gets brighter.</p> <p>2. Press again until desired setting is reached. Flame effect continues to get brighter each time button is pressed.</p>
 FLAME -	<p>FLAME -: Makes flame effect dimmer.</p> <p>NOTE: Flame effect stays on until power button is turned off. Flame effect must be on for heater to turn on.</p>	<p>1. Press once: Flame effect gets dimmer.</p> <p>2. Press again until desired setting is reached. Flame effect continues to get dimmer each time button is pressed.</p>
 HEATER	<p>HEATER button: Turns heater on and off.</p> <p>NOTE: The heater only works when the flame effect is on.</p> <p>NOTE: To prevent overheating, the heater fan will blow cool air for 8-10 seconds before the heater turns on, and after the heater turns off.</p>	<p>1. Press once. Indicator lights up. Fan blows cool air for 10 seconds and 750W heater turns on and blows warm air.</p> <p>2. Press again: Indicator lights up. 1500W heater turns on and blows hot air.</p> <p>3. Press again. Heater turns off.</p>

Remote Control Operation

- This remote control uses two AAA batteries (**Not included**).
- Instructions for battery installation are located in the remote control battery compartment.
- To improve operation of the remote control, aim the remote control at the front of the fireplace. **DO NOT PRESS the buttons too quickly.** Give the unit time to respond to each command.
- **NOTICE: NEVER** dispose of batteries in fire. Failure to observe this precaution **may result in an explosion.** Dispose of batteries at your local hazardous material processing center.

Temperature Limiting Control

This heater is equipped with a Temperature Limiting Control. Should the heater reach an unsafe temperature, the heater will automatically **TURN OFF**. To reset, please do the following:

1. Unplug the power cord from the outlet.
2. Turn ON/OFF switch on the CONTROL PANEL to OFF. Wait 5 minutes for fireplace to cool down.
3. Inspect the fireplace to make sure no vents are blocked or clogged with dust or lint. If they are, use a vacuum to clean the vent areas.
4. With the POWER switch in the OFF position, plug the power cord back into the outlet.
5. If the problem continues, have your outlet and wiring inspected by a professional. If the outlet is OK, please contact our customer support department at 800-215-1990.

Care and Maintenance

Cleaning

- **ALWAYS** turn the heater **OFF** and unplug the power cord from the outlet before cleaning, performing maintenance, or moving the fireplace. Failure to do so could result in electric shock, fire, or personal injury.
- **NEVER** immerse in water or spray with water. Doing so could result in electric shock, fire, or personal injury.

Metal:

- Buff using a soft cloth, slightly dampened with citrus oil-based product.
- **DO NOT** use brass polish or household cleaners, as these products will damage the metal trim.

Glass:

- Use a good quality glass cleaner sprayed onto a cloth or towel. Dry thoroughly with a paper towel or lint-free cloth.
- **NEVER** use abrasive cleansers, liquid sprays, or any cleaner that could scratch the surface.

Vents:

- Use a vacuum or duster to remove dust and dirt from the heater and vent areas.

Plastic:

- Wipe gently with a slightly damp cloth and a mild solution of dish soap and warm water.
- **NEVER** use abrasive cleansers, liquid sprays, or any cleaner that could scratch the surface.

Maintenance

- **RISK OF ELECTRIC SHOCK! DO NOT OPEN any panels. No user-serviceable parts inside!**
- **ALWAYS** turn the heater **OFF** and unplug the power cord from the outlet before cleaning, performing maintenance, or moving the fireplace. Failure to do so could result in electric shock, fire, or personal injury.

Electrical and Moving Parts:

- The fan motors are lubricated at the factory and will not require lubrication.
- Electrical components are integrated in the fireplace and are not serviceable by the customer.

Storage:

- Store fireplace in a clean, dry place when not in use.

Warranty

Touchstone Home Products, Inc warrants our electric fireplaces to be free of defects in material and workmanship for one year from date of purchase. Touchstone will repair or replace any fireplace or fireplace part that is deemed defective or becomes defective during normal use within one year after the date of purchase.

Electrical components, such as fan motor, heater motor, control board, remote control, and control panel are covered under warranty for one year from date of purchase. Touchstone Home Products will provide replacement parts free of charge during the first year of the warranty.

Replacement parts and fireplace units are covered under a 90-day warranty or the remainder of the original one year manufacturer's warranty from original date of purchase, whichever is greater.

Touchstone Home Products, Inc does not warrant its products against damage caused by third parties.

Touchstone Home Products, Inc does not cover damages caused by misuse, alterations, accident, lack of maintenance, abuse or neglect. Parts installed from other manufacturers will void this warranty.

The warranty does not cover paint scratches, cosmetic blemishes, dents, corrosion, or other normal wear and tear associated with the fireplace. Damage to fireplace or other components due to water, weather damage, long periods of dampness, condensation, damaging chemicals or cleaners are not covered under warranty.

This warranty does not cover breakage of fireplace glass panel.

Touchstone Home Products will not be responsible for installation, labor, or any other expenses related to the reinstallation of a warranted part, and such expenses are not covered under warranty.

Extended warranty coverage for the fireplace is available by contacting Touchstone Home Products directly at 1-800-215-1990.

 **CALL US FIRST!** 
DO NOT RETURN TO STORE.

For immediate help with assembly, product information,
or if your product arrives damaged, call our toll-free number at

800-215-1990

or email:

customerservice@thpus.com

Our staff is ready to provide assistance.